

Ductile Iron Butterfly Valves PN16/235PSI/Class125

Dual-Flanged Style, Pin-Free Valve Shaft, Vulcanized Rubber Seat
Design to BS5155 and MSS SP-67
Flange Dimension EN1092-2, ANSI B16.1 Class 125



HB970-G/O
14" - 48"

Sealing Performance	
EPDM	-20°C- 120°C
NBR	-10°C- 80°C

Hydraulic Pressure Test	
Body	2.4Mpa/24Bar
Seat	1.76Mpa/17.6Bar

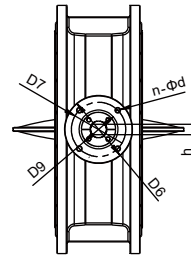

Materials List

No	Part	Specification	BS EN	ASTM
1	Body	Ductile Iron	BSEN 1563	A536 65-45-12
2	Bottom Stem	Stainless Steel	BSEN 10088-1	A582 420
3	Disc	Ductile Iron	BSEN 1563	A536 65-45-12
		Stainless Steel	BS970 304S15	CF8
		Aluminum Bronze	1400AB2	B148 Ay 954
4	Upper Stem	Stainless Steel	BSEN 10088-1	A582 420
5	Seat	EPDM	EPDM	EPDM
		NBR	NBR	NBR
6	Shaft Sleeve	PTFE	PTFE	PTFE
7	Retaining Cap	Steel	BSEN 10087	A307
8	Worm Gear Box	Ductile Iron	BSEN 1563	A536 65-45-12

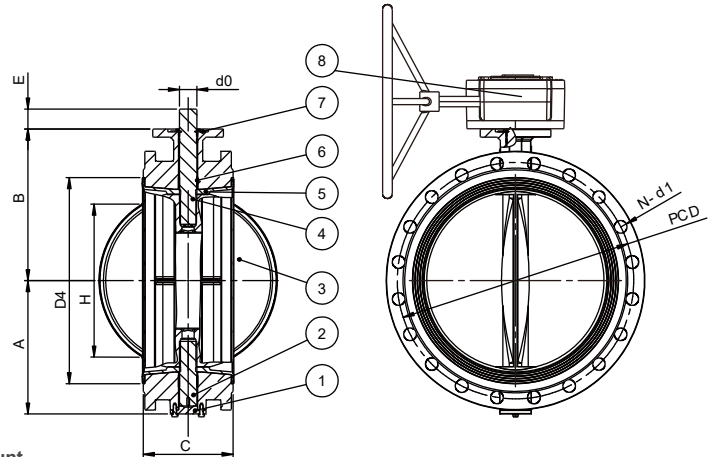

* Suffix - G for operation by worm gear, - O for polished rod
* An electric or pneumatic actuator may be mounted to match an ISO5211-based mount.
Please refer to the TALOAR Butterfly Valve Torque Table in Page 46.

Dimensions-Weights

mm	350	400	450	500	600	700	800
In	14	16	18	20	24	28	32
A	272	296	330	360	447	517	567
B	320	340	375	430	564	616	666
C	190	216	222	229	267	292	318
E	45	50	50	60	60	80	80
H	274	330	378	435	535	635	740
D4	416	460	510	560	660	770	880
d0	31.60	37.95	42.86	45.72	53.98	63.35	63.35
h	24	27	27	32	36	Key18*2	Key18*2
PCD	470	525	585	650	770	840	950
N-d1	16-28	16-31	20-31	20-34	20-37	20-37	24-40
D6	125	175	175	175	210	300	300
D7	102	140	140	140	165	254	254
D9	70	100	100	100	130	130	130
n-φd	4-12	4-18	4-18	4-18	4-23	8-18	8-18
ISO5211	F10	F14	F14	F14	F16	F25	F25
Weight	Lbs	172	251	304	445	699	926
	Kg	78	114	138	202	293	420

* Applicable to cold/hot water systems of air-conditioners, municipal water supply systems, water treatment facilities and industrial plants.