

Fully Welded Ball Valves

PN16/235PSI/Class125

Reduced Bore, Worm Gear, Fixed Ball
Design to EN488
Pressure Test to EN12266.1



WB3618-G
FXF

Materials List		
1	Body	A106-B, EN10217-2
2	Welded Pipe	A106-B, EN10217-2
3	Spring	AISI 304, EN10088-3
3a	Fireproof Gasket	AISI 304
4	O-Ring	Viton
5	Seat Ring	PTFE 25%C
6	Ball	AISI 304, EN10088-3
7	Stem Guide	A106-B, EN10217-2
8	Stem	ASTM A420, EN10088-3
9	Lock Key	AISI 1045
10	Bearing	AISI 304 PTFE
11	Anti-Static Device	AISI 304
12	Fixing Bushing	ASTM A105
13	O-Ring	Viton
14	Closure	ASTM A53-F
15	Bottom Bushing	A106-B, EN10217-2
16	Bearing	AISI 304 PTFE
17	Gland Cover	A106-B, EN10217-2
18	O-Ring	AViton
22	Gland	A106-B, EN10217-2
23	ISO Flange	ASTM A105
24	Bolt	ASTM A193-B7
25	Spring Washer	ASTM 1566
26	Gearbox	ASTM A536
27	Lock Key	AISI 1045
28	Lifting Lug	ASTM A53-F

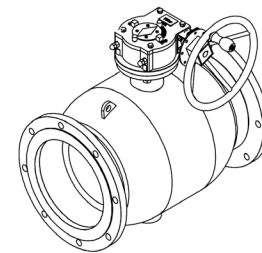
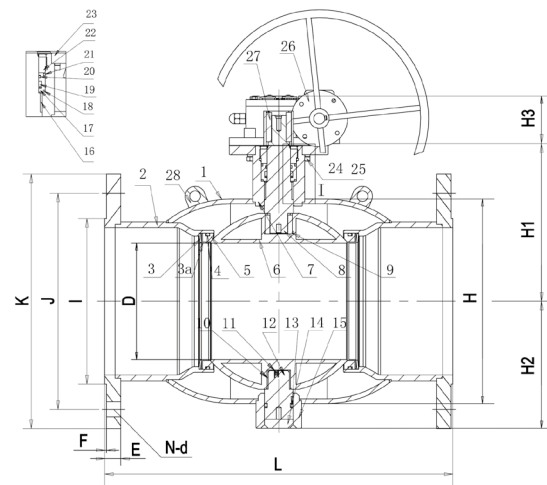

* Operating temperature range: -30°C ~ +200°C .
* For other materials and special requirements, please consult the factory or the local offices.

Dimensions/Weights															
In	D	H	L	H1	H2	H3	I	J	K	E	F	N-d	Kv s	Lbs	Kg
6	125	219	403	182	150	81	210	240	280	24	3	8-Φ23	1120	126	57
8	150	273	502	226	174	81	265	295	335	26	3	12-Φ23	1620	187	85
10	200	351	568	267	230	81	320	355	405	30	3	12-Φ25	3300	291	132
12	250	426	648	307	277	90	375	410	460	30	4	12-Φ25	4600	531	241

* Please consult the engineers for full-bore dimensions.

Fully Welded Ball Valves

PN16/235PSI/Class125

Reduced Bore, Worm Gear, Fixed Ball
Design to EN488
Pressure Test to EN12266.1



WB3618-G
Fx F

Materials List		
1	Body	A106-B, EN10217-2
2	Welded Pipe	A106-B, EN10217-2
3	Baffle	ASTM A105
4	Spring	AISI 304, EN10088-3
5	Seat Ring	PTFE 25%C
6	Pressure Ring	ASTM A105
7	Ball	AISI 304, EN10088-3
8	Stem Guide	A106-B, EN10217-2
9	Stem	ASTM A420, EN10088-3
11	O-Ring	Viton
12	Bearing	AISI 304 PTFE
13	Anti-Static Device	AISI 304
14	Fixing Bushing	ASTM A105
15	O-Ring	Viton
17	End Cap	ASTM A53-F
18	Screw	ASTM A193-B7
19	Closure	ASTM A53-F
20	Bottom Bushing	AISI 1020
21	O-Ring	Viton
23	Gland	AISI 1020
24	O-Ring	Viton
26	ISO Flange	ASTM A105
27	Spring Washer	ASTM 1566
28	Bolt	ASTM A193-B7
29	Lock Key	AISI 1045
30	Gearbox	ASTM A536
31	Exhaust Valve	AISI 1025
32	Lifting Lug	ASTM A53-F
33	Seat	ASTM A53-F

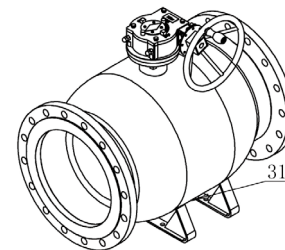
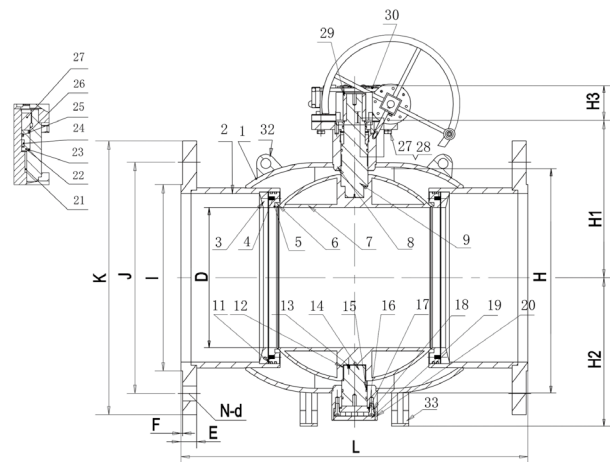

* Operating temperature range: -30°C ~ +200°C .
* For other materials and special requirements, please consult the factory or the local offices.

Dimensions/Weights															
In	D	H	L	H1	H2	H3	I	J	K	E	F	N-d	Kvs	Lbs	Kg
14	300	508	762	347	335	96	435	470	520	34	4	16-Φ25	8300	774	351
16	335	560	838	384	376	107	485	525	580	36	4	16-Φ30	12500	1096	497
18	385	640	914	425	425	107	545	585	640	40	4	20-Φ30	15300	1716	778
20	438	735	991	480	497	107	608	650	705	44	4	20-Φ34	18000	1819	825

* Please consult the engineers for full-bore dimensions.

Fully Welded Ball Valves

PN16/235PSI/Class125

Reduced Bore, Worm Gear, Fixed Ball
Design to EN488
Pressure Test to EN12266.1



WB3618-G
FXF

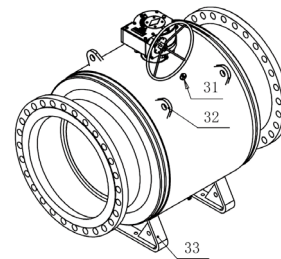
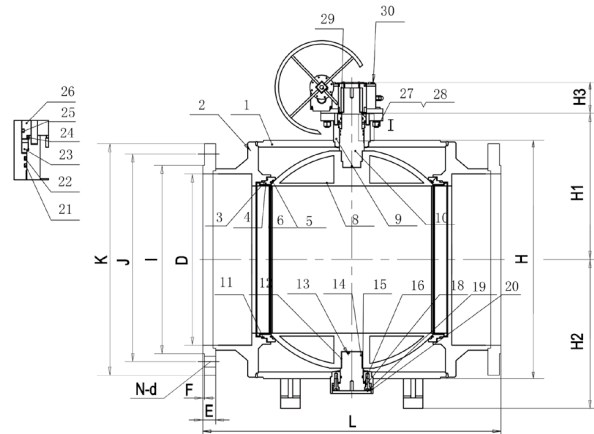

Materials List		
1	Body	A106-B, EN10217-2
2	Welded Pipe	A106-B, EN10217-2
3	Baffle	ASTM A105
4	Spring	AISI 304, EN10088-3
5	Seat Ring	PTFE 25%C
6	Pressure Ring	ASTM A105
7	Ball	AISI 304, EN10088-3
8	Stem Guide	A106-B, EN10217-2
9	Stem	ASTM A420, EN10088-3
11	O-Ring	Viton
12	Bearing	AISI 304 PTFE
13	Anti-Static Device	AISI 304
14	Fixing Bushing	ASTM A105
15	O-Ring	Viton
18	Screw	ASTM A193-B7
19	Closure	ASTM A53-F
20	Bottom Bushing	AISI 1020
21	O-Ring	Viton
23	Gland	AISI 1020
24	O-Ring	Viton
26	ISO Flange	ASTM A105
27	Spring Washer	ASTM 1566
28	Bolt	ASTM A193-B7
29	Lock Key	AISI 1045
30	Gearbox	ASTM A536
31	Exhaust Valve	AISI 1025
32	Lifting Lug	ASTM A53-F
33	Seat	ASTM A53-F

* Operating temperature range: -30°C ~ +200°C .

* For other materials and special requirements, please consult the factory or the local offices.

Dimensions/Weights															
In	D	H	L	H1	H2	H3	I	J	K	E	F	N-d	Kvs	Lbs	Kg
24	590	805	1143	546	540	125	718	770	840	48	5	20-Φ41	29000	2763	1253
28	685	965	1346	625	635	146	788	840	910	50	5	24-Φ41	35000	4831	2191
32	780	1120	1524	702	710	157	898	950	1020	52	5	24-Φ41	52000	6880	3120
36	874	1280	1727	790	810	157	998	1050	1120	54	5	28-Φ41	58000	9916	4497
40	976	1410	1900	865	885	187	1110	1170	1255	56	5	28-Φ48	75000	13199	5986
48	1166	1570	2180	965	980	187	1325	1390	1485	58	5	32-Φ54	108000	18335	8315

* Please consult the engineers for full-bore dimensions.